



romex WC 3 SL

Min conductor	6 mm	0.230"
Max conductor	110 mm	4.330"
Max over insulation	120 mm	4.725"
Max tube die diameter	125 mm	4.920"

Use

Domain of use	Jacketing of any type of cable up to 11 mm
Compound	PVC / PE / PA / LSZH / XLPE

romex

Characteristics

romex WC 3 SL

	Manual centering
SL	Single Layer
Distribution mono-flow	Conical distribution cartridge Easy to clean-no holes or slots-no dead spots Constant and smooth compound flow No stress and no shear in the melted compound
Heating	Heating collar

Design

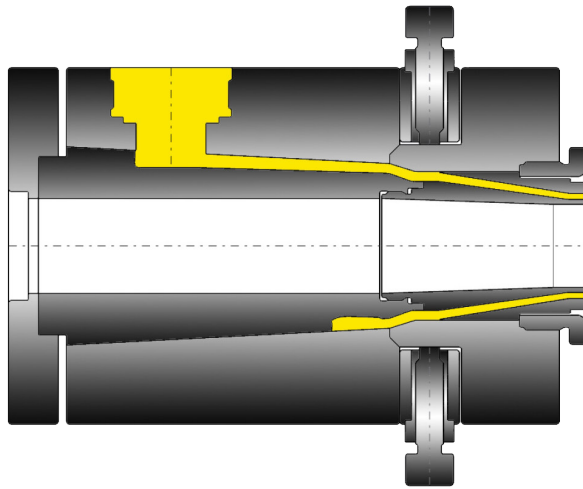

Options

Connections	Connecting flanges for any type of extruder
By pass	Manual - Pneumatic - Hydraulic
Distributor	Special distribution cartridges for any compound
Tooling	Hardened steel Semi-compression Tube Special tooling - Figure eight - Twin cable... Design recommendation upon request
Accessories	Assembly and disassembly cleaning kit Vacuum adapter
Spare parts	Permanent stock, shipment within 24 hours
Services	Microdia answers your request within 24 hours Technical assistance - Engineering - Commissioning